



**1:10 SCALE FOUR WHEEL STEERING ELECTRIC POWERED ROCK CRAWLER**

**TECHNICAL DATA:**

TYPE	LENGTH	WIDTH	HEIGHT	WHEELBASE	GROUND CLEARANCE	WHEEL DIAMETER	WHEEL WIDTH	GEAR RATIO
CRAWLER	440mm	230mm	275mm	320mm	81mm	132mm	57mm	40:1

# INSTRUCTION MANUAL

MAN-RIDGEROCK-BG-2022-4-19

- To ensure you are using the most recent version of this manual visit: [www.redcatracing.com/pages/manuals](http://www.redcatracing.com/pages/manuals)

**PLEASE READ AND UNDERSTAND  
ALL INSTRUCTIONS CAREFULLY BEFORE USE.**

**MAIN FEATURES:**

- 2.4GHz Radio System
- 4 Wheel Drive/4 Wheel Steering
- Solid Axles with 4-Link Suspension
- Aluminum Capped Oil Filled Shocks
- 2x RC380 Electric Motors (Front and Rear)
- Scale Roll Cage With Realistic Cockpit And Drivers
- TVP Chassis Design
- Li-ion 7.4V, 1500mAH Battery Pack, with USB Balance Charging Cable (Cell phone adapter not included)
- Battery Tray Allows Room For Optional Battery

**GENERAL SAFETY INFORMATION:**

Never operate the vehicle in crowds of people. Serious injury may occur. Never operate the vehicle on public streets as traffic accidents, personal injury and/or property damage may occur. This vehicle is ONLY to be driven in open areas safe for RC cars.

Do NOT use this vehicle to chase pets or other animals. The receiver, steering servo and other electronics installed in this vehicle are merely splash-resistant, and are not intended to be submerged in water. Do not use or put this vehicle into water. Check the transmitter (radio controller) power level often and replace the batteries if they get low on power. Remove the batteries from the transmitter (radio controller) when not in use. Replace with fresh batteries if necessary. NEVER run this vehicle with low or old transmitter batteries. When this vehicle becomes stuck, do NOT try to muscle it out with the throttle. Doing so may cause damage to the motor and/or the ESC (Electronic Speed Controller). If the vehicle is stuck, pick it up by hand and set it down in a safe area. Check and clean obstacles before running again. Before running this vehicle, be sure the battery connectors are plugged in firmly. Any malfunction caused by unauthorized upgrading and modification of this vehicle, or related components, will void the warranty.

**OPERATING PRECAUTIONS:**

Be careful not to touch any moving parts when the vehicle is in use, or when servicing this vehicle as this may cause injury. To prevent excessive R.P.M. from damaging the motor, and/or the drive-train components, we suggest reducing the throttle while in the air during jumps. Never attempt to disassemble the motor, ESC, servo, or receiver. These electrical components have been calibrated for precision at the factory.

If you purchase upgraded parts for this vehicle, be sure to install all the parts that come in the package. For example, if you upgrade the motor, you must upgrade the ESC and available drive-train components as well. This will limit component damage and failure. To run this vehicle, turn on the transmitter (radio controller) first and then the receiver. When you are done running this vehicle, turn off the receiver first, and then the transmitter (radio controller). Always have the transmitter (radio controller) turned on any time the vehicle is turned on to prevent a runaway vehicle. Never cut the receiver antenna, as it will lessen the radio signal to the vehicle, causing damage and/or injury. When the vehicle is not in use, always switch off the power and unplug the battery pack. Always allow the battery to completely cool before charging it. Never overcharge the battery pack as it will damage the battery and may cause a fire, damage, and/or injury/death. Be sure to check the battery pack for excessive heat build-up during charging. If the battery pack is too hot to touch, STOP CHARGING and disconnect the battery from the charger. Do NOT charge battery pack unattended. Only charge the battery on a fire proof surface, away from anything flammable or combustible.

Children are NOT allowed to charge the battery pack unless closely supervised by an adult. Do NOT attempt to dismantle and modify the battery pack or the charger in ANY way.

Do NOT attempt to repair a damaged or swollen battery pack. Discontinue use immediately and dispose of the battery pack according to your local laws and ordinances. You may buy a new battery pack to continue having fun with your RC vehicle.

## INTRODUCTION:

**RIDGEROCK**

- This 1:10 scale, four wheel steering rock crawler is designed to be fun and uses quality parts for durability and performance.
- This vehicle requires regular maintenance for best performance.
- Failure to maintain this vehicle will harm its performance. The spare parts pages in the manual make buying broken or worn out parts easy. Be sure to clean this vehicle from dirt and debris after each use.
- This vehicle is not a toy, but an authentic hobby grade vehicle which is not suitable for users under 14 years of age unless supervised by an adult.
- Use ONLY the factory manufactured parts to upgrade your vehicle. To avoid broken parts, we recommend upgrading the drive train when upgrading the motor and ESC.
- Any malfunction caused by unauthorized custom modifications will void the warranty.

## SAFETY NOTES:

- Be careful not to touch any moving parts when servicing this vehicle. Serious injury could result.
- To prevent excessive R.P.M. from damaging the motor, and/or the drivetrain components, we suggest reducing the throttle while the vehicle is in the air during jumps.
- Never attempt to disassemble the motor, ESC, servo, or receiver. These electrical components have been calibrated for performance at the factory.
- If you purchase upgraded parts for this vehicle, be sure to install all the parts that come in the package. For example, if you upgrade the motor, you must upgrade the ESC and available drivetrain components as well. This will limit component damage and failure.
- To run this vehicle, turn on the transmitter (radio controller) first and then the receiver.
- When you are done running this vehicle, turn off the receiver first, and then the transmitter (radio controller). Always have the transmitter (radio controller) turned on any time the vehicle is turned on to prevent a runaway vehicle.
- Never cut the receiver antenna, as it will lessen the radio signal to the vehicle, causing damage and/or injury.
- Always switch off the power and unplug the battery pack when not in use.
- Always allow the battery to completely cool before charging it.
- Never overcharge the battery pack as it will damage the battery and may cause a fire, damage, and/or injury/death.
- Be sure to check the battery pack for excessive heat build-up during charging. If the battery pack is too hot to touch, STOP CHARGING and disconnect the battery from the charger.
- Do NOT charge battery pack unattended. Only charge the battery on a fire proof surface, away from anything flammable or combustible.
- Children are NOT allowed to charge the battery pack unless closely supervised by an adult.
- Do NOT attempt to dismantle and modify the battery pack or the charger in ANY way.
- Do NOT attempt to repair a damaged or swollen battery pack. Discontinue use immediately and dispose of the battery pack according to your local laws and ordinances. You may buy a new battery pack to continue having fun with your RC vehicle.

## PACKAGING:

- 1x Ready-To-Run Rock Crawler (battery and USB charger provided.)
- 1x Full-Function 3-Channel 2.4GHz Radio Controller (requires 3x AA size Batteries - not included)
- 1x Instruction Manual
- Note: Fully charge the battery pack before use. Install 3x AA batteries (not included) into the radio controller. Unplug and remove the battery pack from the vehicle when not in use.

## 2.4GHz RADIO SYSTEM:

**RIDGEROCK**

Read this section to familiarize yourself with the features of the 3-Channel 2.4GHz radio system included with this vehicle. Read and understand all warnings to ensure the safe operation of your radio control system.

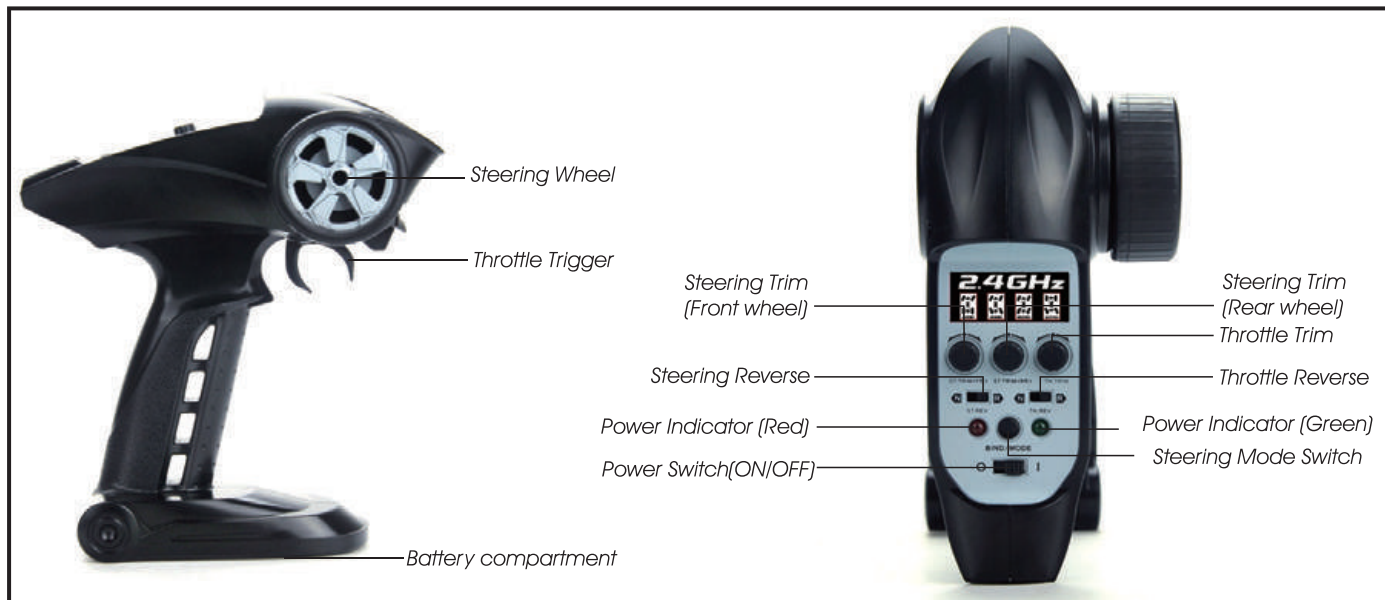

**Steering Wheel:** Proportional steering (left/right). Turn the steering wheel to make the vehicle turn left or right.

**Throttle Trigger:** Proportional throttle (forward and reverse). This controls the speed of your vehicle, both forward and reverse. Pull it to accelerate forward, release it to stop, and push it to drive in reverse.

**Battery Compartment:** Holds three AA size batteries to power the transmitter. (AA size batteries not included.)

**Steering Trim (Front):** Left Knob. Used to set the steering neutral point for the front wheels. If the vehicle veers to one direction, while trying to drive straight, because the front wheels are not centered correctly, turn this knob in the opposite direction until the vehicle drives straight.

**Steering Trim (Rear):** Middle Knob. Used to set the steering neutral point for the rear wheels. If the vehicle veers to one direction, while trying to drive straight, because the rear wheels are not centered correctly, turn this knob in the opposite direction until the vehicle drives straight.

**Throttle Trim:** Right Knob. Used to set the throttle neutral point. If the vehicle moves forward or reverse while the throttle trigger is centered, turn this knob until the vehicle remains still.

**Steering Reverse Switch:** Used to change steering orientation. If the vehicle turns right when you steer left, flip this switch.

**Throttle Reverse Switch:** Used to change throttle direction. If the vehicle goes backwards when you pull the trigger, flip this switch.

### **Power Indicators (Red/Green):**

The lights indicate the current status of the transmitter batteries. When both power indicator lights are illuminated, the batteries have sufficient capacity to power the transmitter safely. If the green power indicator light begins to flash, the batteries are losing power and should be replaced soon. If both power indicator lights begin to flash, the batteries have only limited capacity to power the transmitter. In this case, the batteries should be replaced as soon as is safely possible.

**Power Switch (ON/OFF):** Switching the transmitter on or off.

**Steering Mode Button:** Used to cycle through the steering modes.

**STEERING MODE - 1**

FRONT WHEEL STEERING.

Light is on solid.

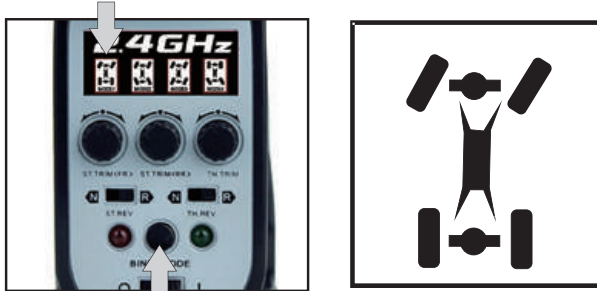

PRESS IT TO CHANGE THE STEERING MODE

**STEERING MODE - 2**

FRONT AND REAR WHEEL  
STEER IN OPPOSITE DIRECTION.

Light is on solid.

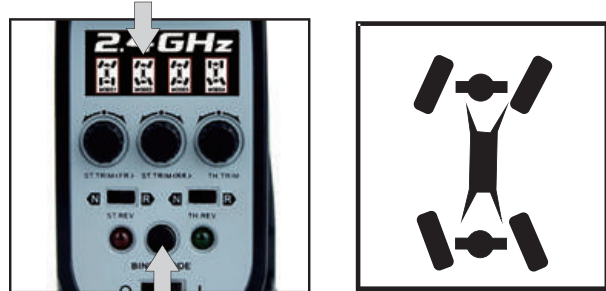

PRESS IT TO CHANGE THE STEERING MODE

**STEERING MODE - 3**

FRONT AND REAR WHEEL  
STEER IN SAME DIRECTION

Light is on solid.

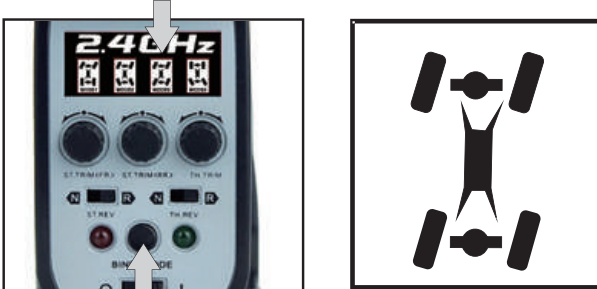

PRESS IT TO CHANGE THE STEERING MODE

**STEERING MODE - 4**

REAR WHEEL STEERING

Light is on solid.



PRESS IT TO CHANGE THE STEERING MODE

**INSTALLING/REPLACING THE TRANSMITTER BATTERIES**

The battery cover is located on bottom. Slide the battery cover off, load 3x AA batteries into the battery compartment (line up (+ to +) & (- to -)), then replace the battery cover.

**Note:**

- 1) Do not mix old and new batteries.
- 2) Use batteries of same type and brand.
- 3) Remove the batteries when not in use.
- 4) Never reverse the polarities.
- 5) Always line up the battery "+" to the radio "+" mark.
- 6) NEVER line up the "+" marks to the "-" marks.
- 7) When the radio battery levels get low, replace with all new batteries.



**1) TURNING ON THE RADIO**



Slide the radio power switch to the "ON" position.  
 "O" = OFF      "I" = ON

**2) TURNING ON THE VEHICLE**

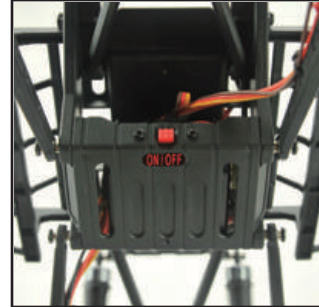

With a fully charged battery installed and properly plugged in, press and hold the power button, located on the chassis, to power up the vehicle.

**3) CHECK THE STEERING**

With the radio and vehicle turned on:



- 1) With the steering wheel centered, the vehicle will run in a straight line.
- 2) With the steering wheel turned to the left, the vehicle will steer to the left.
- 3) With the steering wheel turned to the right, the vehicle will steer to the right.

If the vehicle turns right when you steer left, flip the "Steering Reverse" switch.

If the vehicle turns left when you steer right, flip the "Steering Reverse" switch.

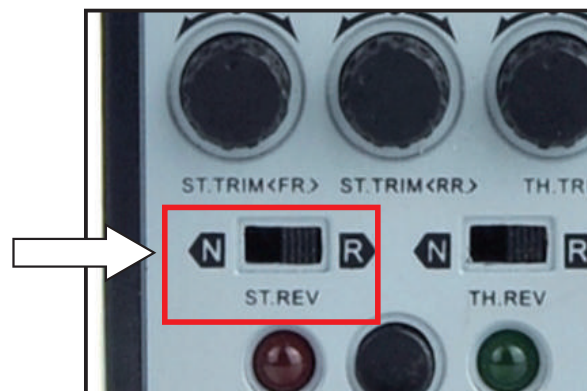

**4 CHECKING THE THROTTLE**

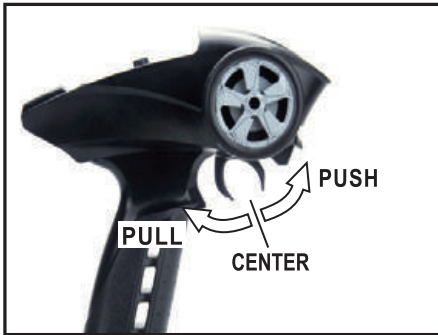

Pull the trigger to drive forward, release it to stop, and push it to drive in reverse.

If the vehicle drives backwards when you pull the trigger, flip the "Throttle Reverse" switch.

If the vehicle drives forwards when you push the trigger, flip the "Throttle Reverse" switch.

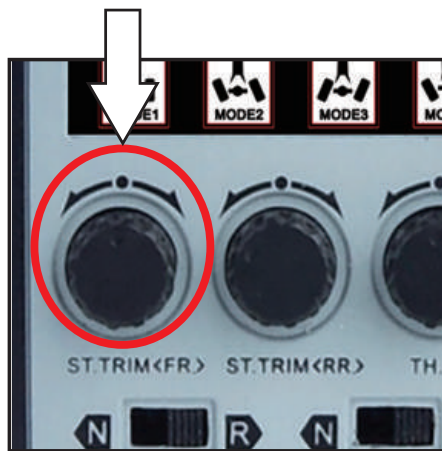
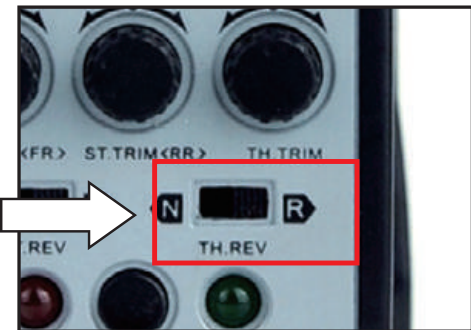

**Steering Trim (Front):**

Used to set the steering neutral point for the front wheels. If the vehicle veers to one direction, while trying to drive straight, because the front wheels are not centered correctly, turn this knob in the opposite direction until the vehicle drives straight.

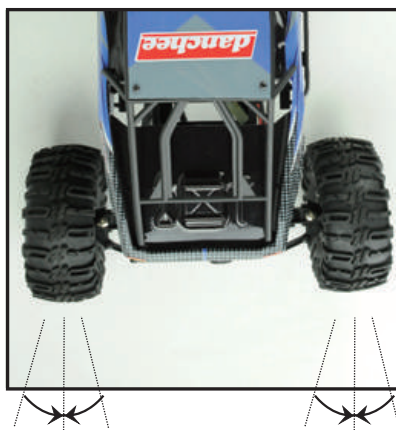
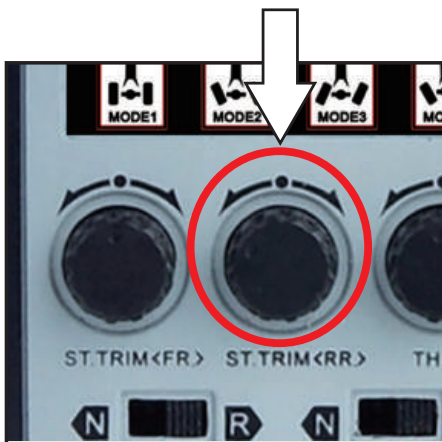

**Steering Trim (Rear):**

Used to set the steering neutral point for the rear wheels. If the vehicle veers to one direction, while trying to drive straight, because the rear wheels are not centered correctly, turn this knob in the opposite direction until the vehicle drives straight.

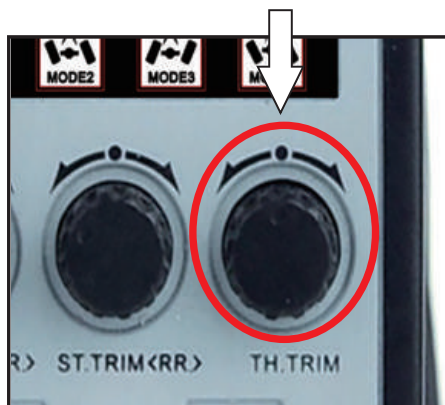

**Throttle Trim:**  
Used to set the throttle neutral point. If the vehicle moves forward or reverse while the throttle trigger is centered, turn this knob until the vehicle remains still.

**1 TURNING OFF THE VEHICLE**

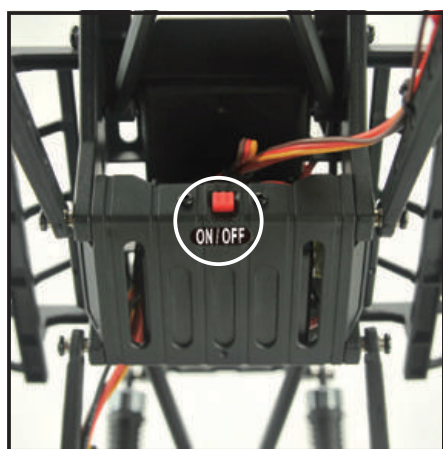

Press and hold the power button, located on the chassis, for 1-2 seconds to switch off the vehicle. The LED turns off when the ESC is switched off.

**2 TURNING OFF THE RADIO**



Slide the radio power switch to the "OFF" position to turn off the radio.

"0" = OFF      "1" = ON

**3 DISCONNECT AND REMOVE THE BATTERY PACK**



Unplug the battery pack and remove it from the vehicle when not in use.

Charge the battery pack before storing it in a clean and dry place.

Do not expose the battery pack to any source of heat or humidity.

**3 DISCONNECT AND REMOVE THE BATTERY PACK**



Check and clean the vehicle before storing it.

- 1) Check the wheels for tightness.
- 2) Check all wires and connections for stripped insulation or breakage. Be sure the battery is unplugged and removed from the vehicle. (See 3)
- 3) Use a soft cloth or clean paintbrush to wipe away dirt. Store the car in a clean dry place.



## CHARGING THE BATTERY PACK:

RIDGEROCK

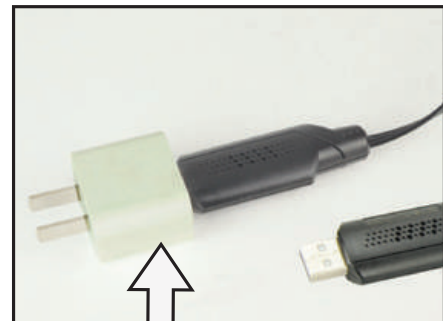
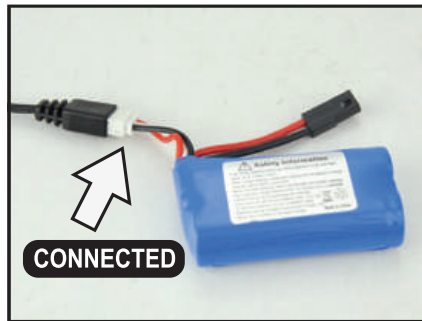

Your product is supplied with a refined USB charging cable.

Specifications: (Input: DC 5V, 2A, Output: 7.4V==1.3A)

Take out the battery pack from the model, connect the battery pack to the USB charger (provided), and plug the USB charger into an appropriate USB power supply.

**During charging, the red LED is on solid, which monitors the charging process.**

**The red LED will go off after the battery pack has been fully charged.**

**Charging Duration:** Li-ion 7.4V, 1500mAh (Approx. 4.5-5 hours)

**Tip:** Smart phone AC POWER adaptors (5V, 2A) can be applied to cut down charging period.

**When the red LED flashes, which indicates:**

- 1) USB charging cable is connected with the battery pack but not being plugged on the charging slot.
- 2) Non-rechargeable battery pack is connected
- 3) Not able to charge as the battery pack is over-discharged.
- 4) USB cable is in an unstable connection.



**Be sure to always disconnect the battery pack and remove it from vehicle when not in use. ONLY use the USB charger supplied with this vehicle to charge the included battery.**

**NEVER** charge the battery under any wet or damp conditions. Only charge in dry conditions.  
**NEVER** expose the battery to heat. Never charge battery unattended.

**NEVER** charge a battery pack while it is still in the vehicle.  
**NEVER** completely drain the battery pack while running the vehicle.  
**NEVER** leave the battery pack uncharged for long periods of time.

**Failure to follow these warnings greatly increases the risk of damage, fire, or explosion.**

## PLUGGING IN THE ELECTRONICS:

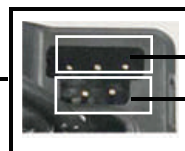
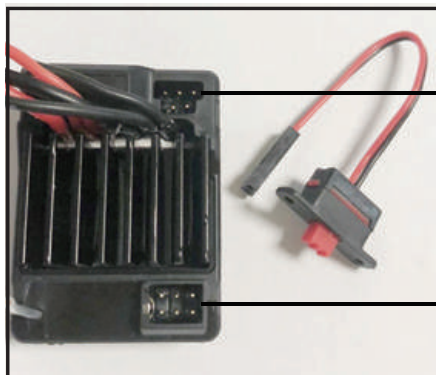

AUX. POWER CHANNEL  
POWER SWITCH PLUG LOCATION

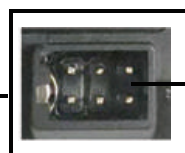

2 x SERVO PLUG LOCATION

## REGULAR MAINTENANCE:

**RIDGEROCK**

We recommend that you check and maintain this vehicle after each use. Follow the suggestions below to help ensure consistent performance of this vehicle.

- Disconnect and remove the batteries from both the vehicle and the radio.
- Inspect the vehicle for any obvious damage.
- Check the gears for wear, loose debris or broken/stripped teeth.
- Check the wheels for tightness. Tighten the wheel nuts if needed.
- Check the chassis for loose screws. Tighten if needed.
- Check the wiring for frayed or damaged wires and/or connectors.
- Check the batteries in the vehicle and in the radio controller for damage. Replace old AA batteries in the radio.
- Keep the chassis clean and free of sand, dust and moisture.
- Make sure the drive-train is free from binding (twisted grass, hair, or string) and clean if necessary.
- Clean the motor if necessary. (Never attempt to disassemble the motor.)
- Clean the body with a soft lint-free cloth.
- Store the vehicle in a clean and dry place out of children's reach. Storage conditions should be dry and cool. Never expose the vehicle or components to heat or water.
- Check the steering servo for looseness or clicking. This component will wear out over time and may need to be replaced.

## TROUBLESHOOTING:

### **The vehicle does not work at all:**

- Be sure the radio and vehicle are both turned on.
- Check for damaged parts/wires/connectors, repair or replace if necessary.
- Be sure the radio has fresh AA batteries and the vehicle has a fully charged battery pack plugged in correctly.

### **The vehicle runs slowly:**

- Vehicle battery is low. Charge the battery pack (after it has time to cool).
- Be sure the vehicle is geared properly and there aren't any dirty or stripped gears. Be sure the motor pinion and spur gear are set with correct gear mesh.
- Be sure all moving parts can move freely and clean them if needed.

### **The throttle works but the steering doesn't:**

- Check if the servo feels jammed, and try centering it gently if it is the case.
- Be sure the servo links are connected and not binding. Be sure the servo isn't broken and replace if necessary.

### **It steers, but the throttle doesn't work:**

- Check for damaged drive-train parts.
- Be sure there are charged, or new, batteries in both the vehicle and radio.

### **The vehicle runs, but it is very noisy:**

- Check gear mesh between the spur gear and the motor pinion gear.
- Check if there are stripped and/or dirty gears.
- Check for damaged drive-train parts.

### **One direction of steering travel greater than the other:**

- Set the steering trim to the steering center point.

### **The battery pack won't charge:**

- Check to see if the battery pack or charger is damaged. Be sure the battery pack hasn't been discharged beyond its safe limit.

# EXPLODED VIEW - 1

RIDGEROCK

## DRIVE SHAFT ASSEMBLY (FRONT/REAR)

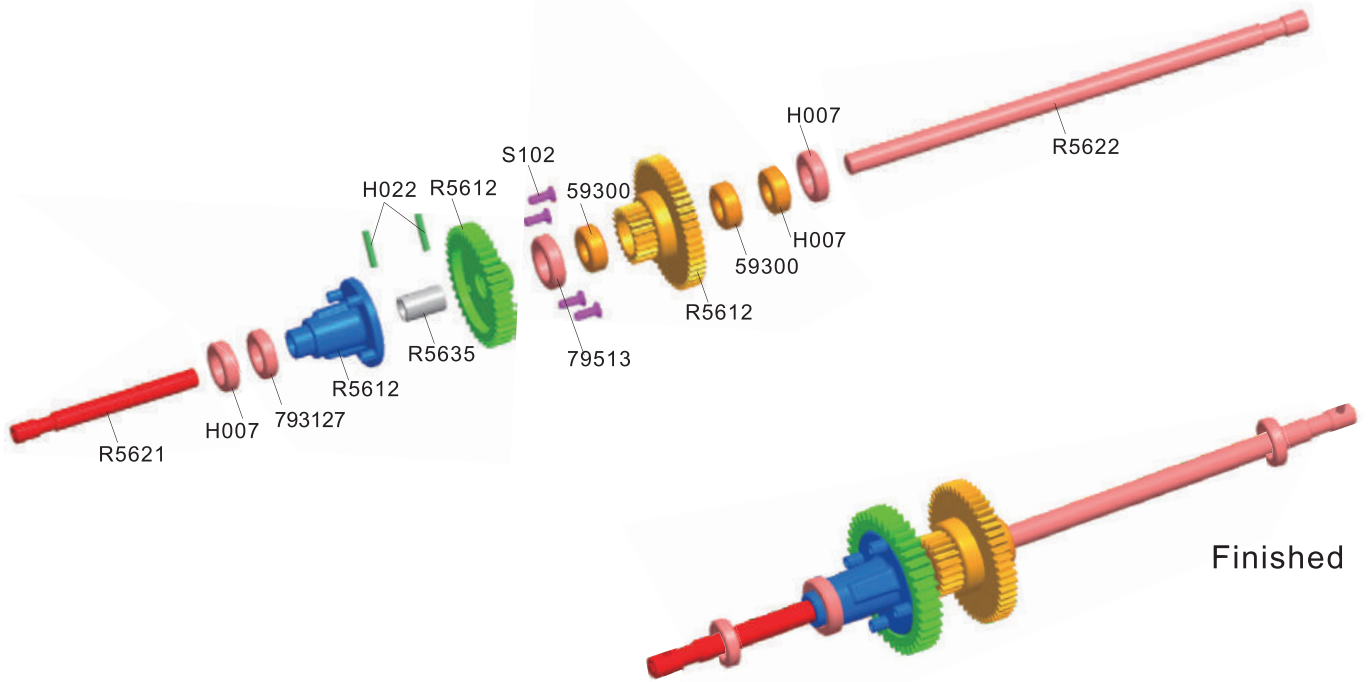

## AXLE ASSEMBLY (FRONT/REAR)

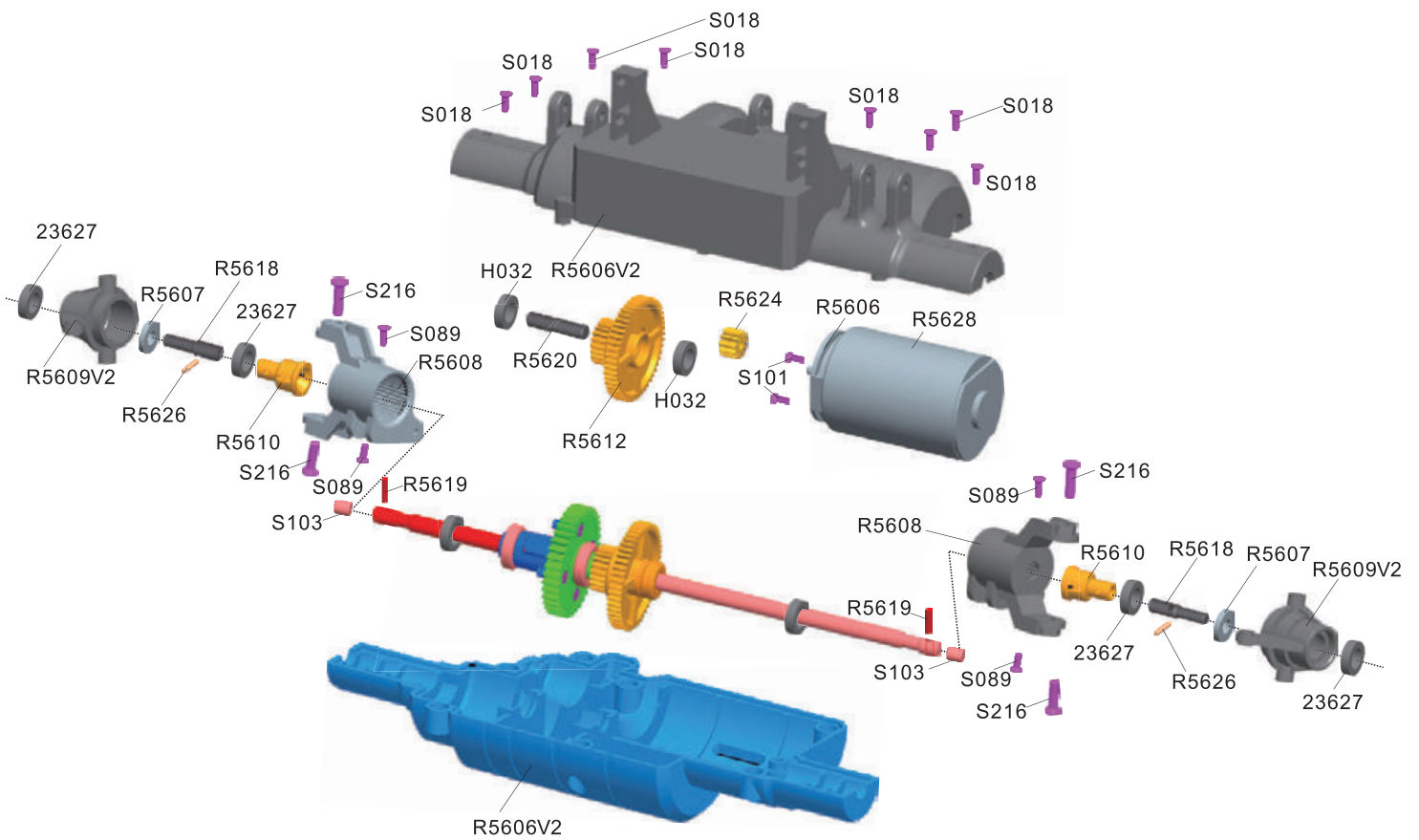

# EXPLODED VIEW - 2

**RIDGEROCK**

## SERVO INSTALLATION (FRONT/REAR)

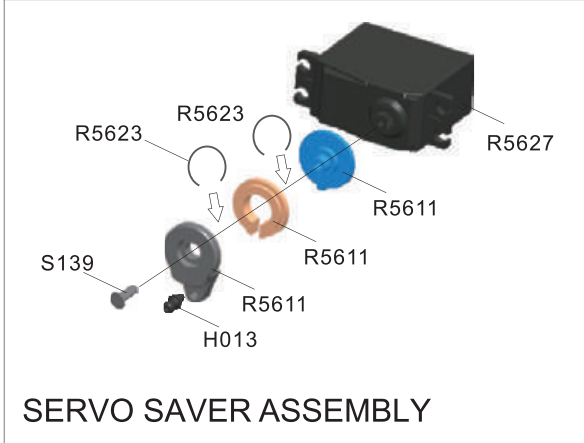
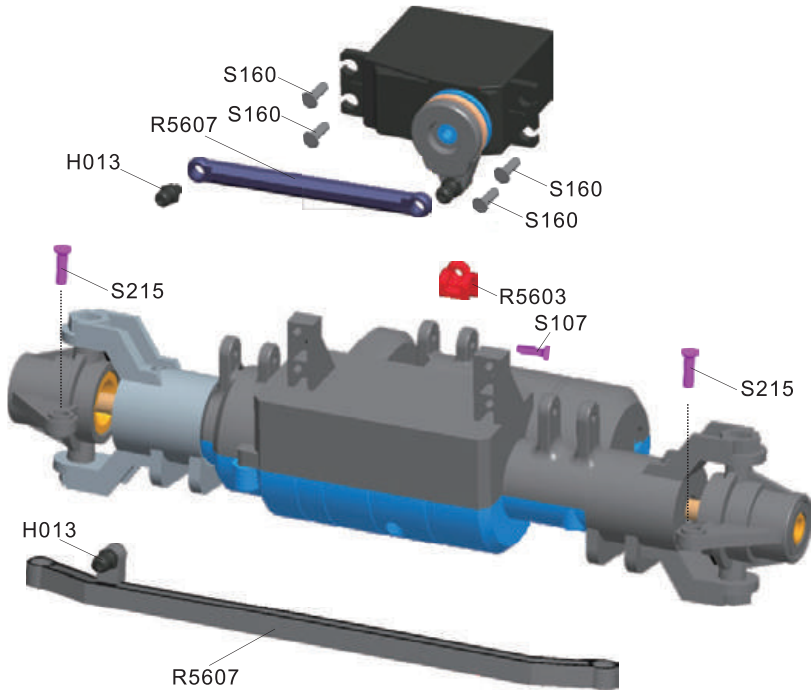

## ROLL CAGE AND BODY INSTALLATION

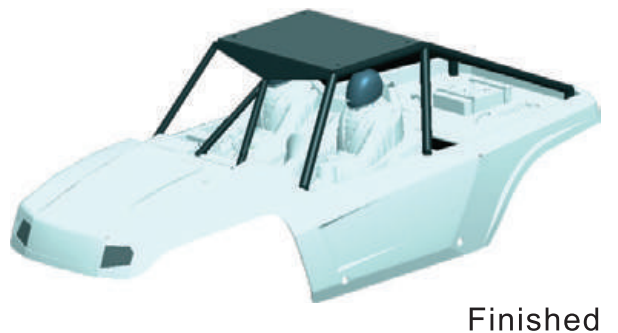
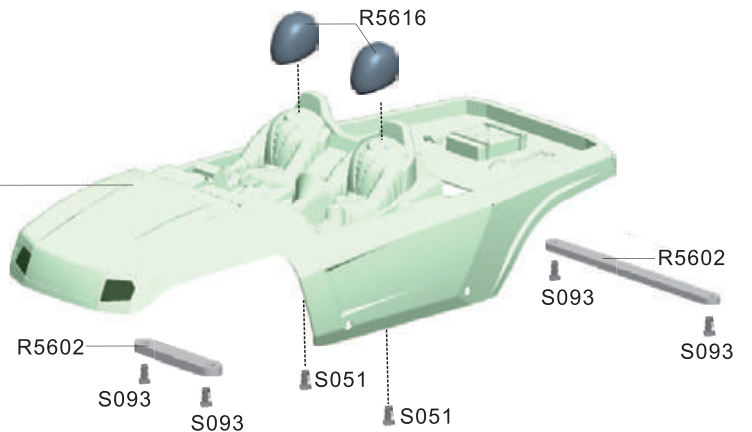
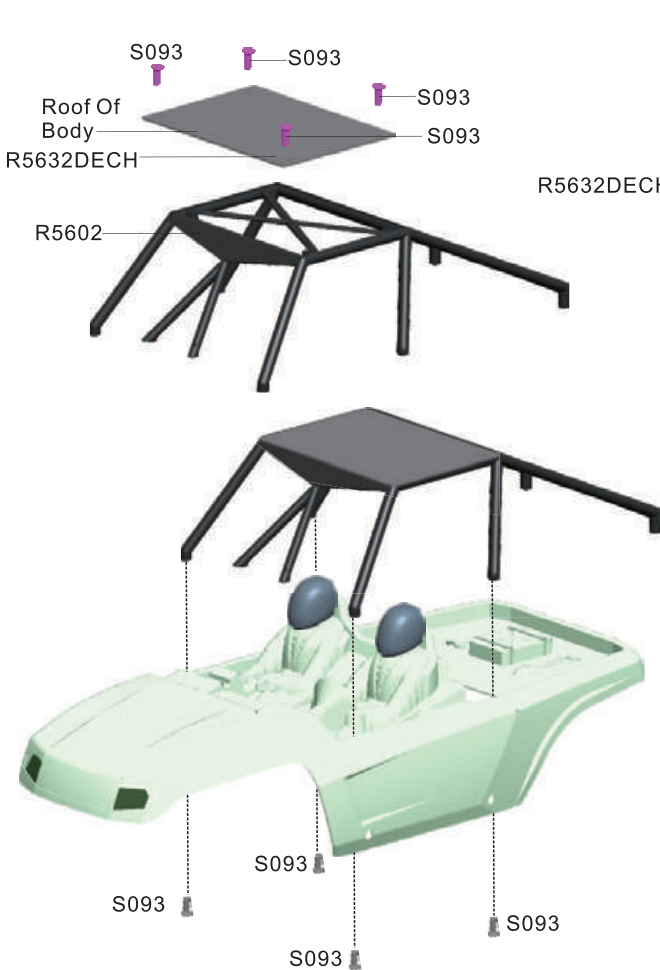

# EXPLODED VIEW - 3

RIDGEROCK

## CENTER UNIT ASSEMBLY

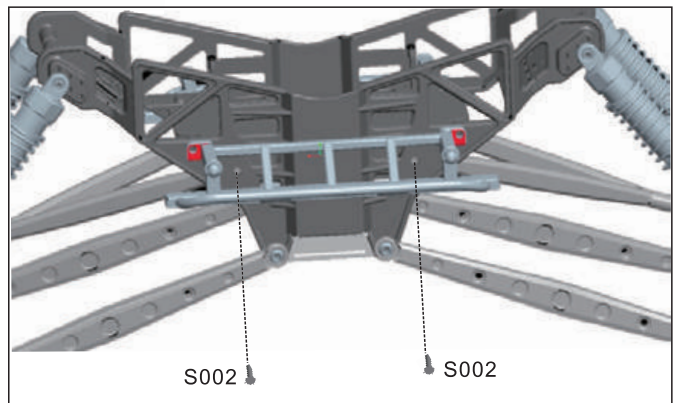
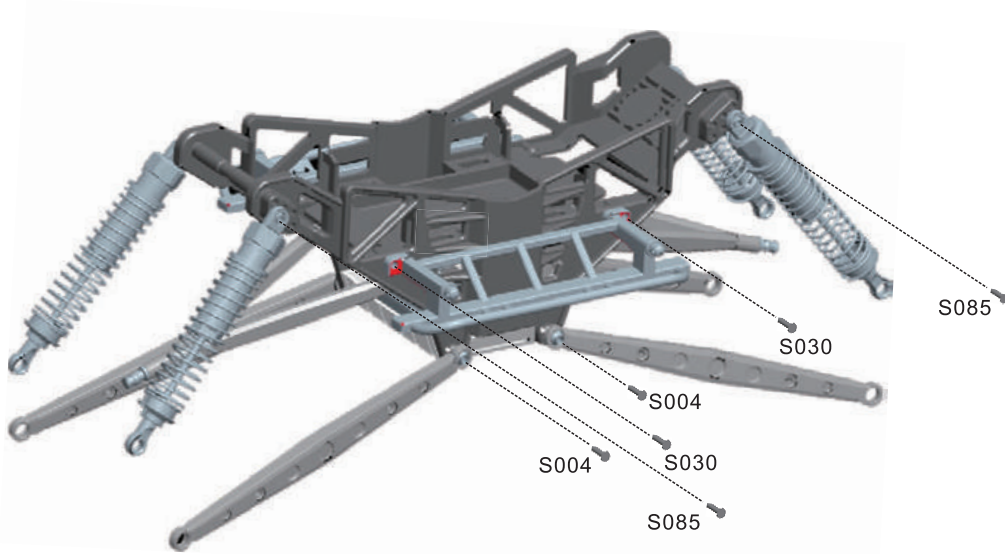
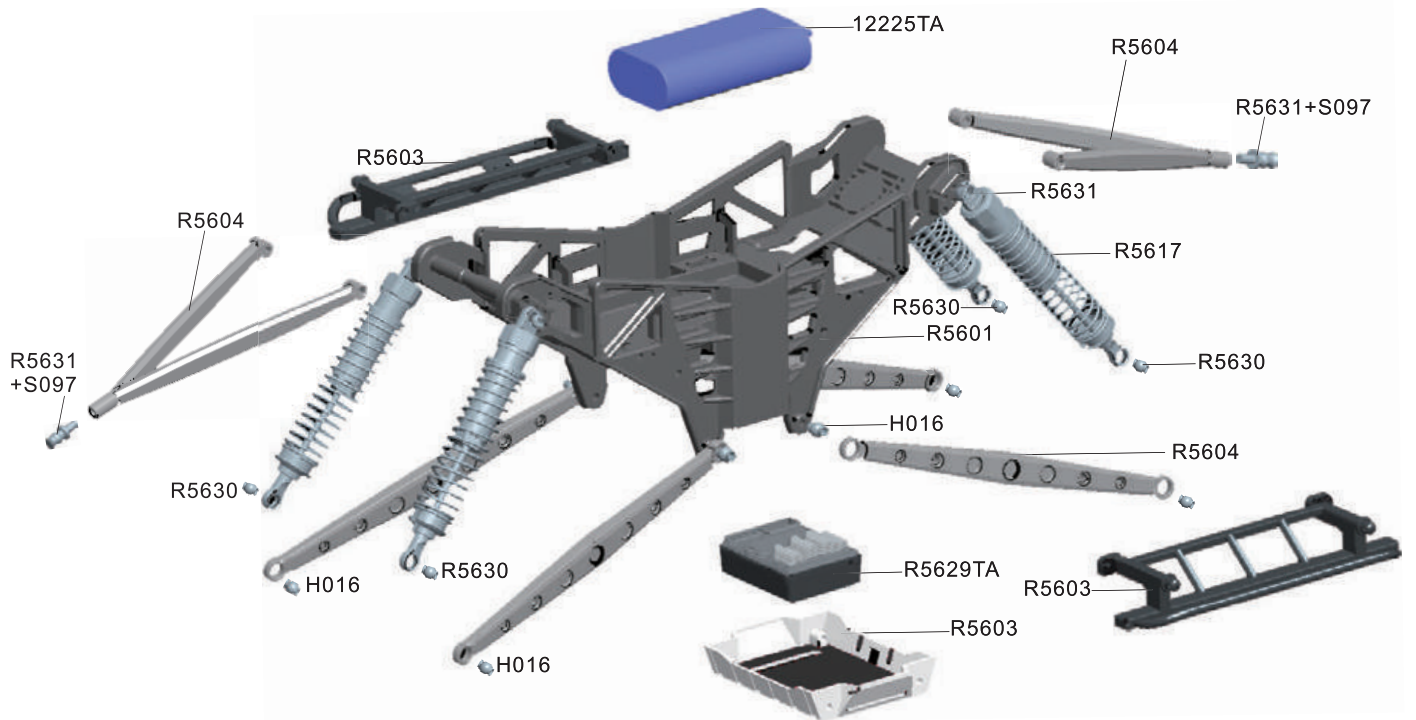

# EXPLODED VIEW - 4

RIDGEROCK

## CONNECT CENTER UNIT TO FRONT/REAR AXLE

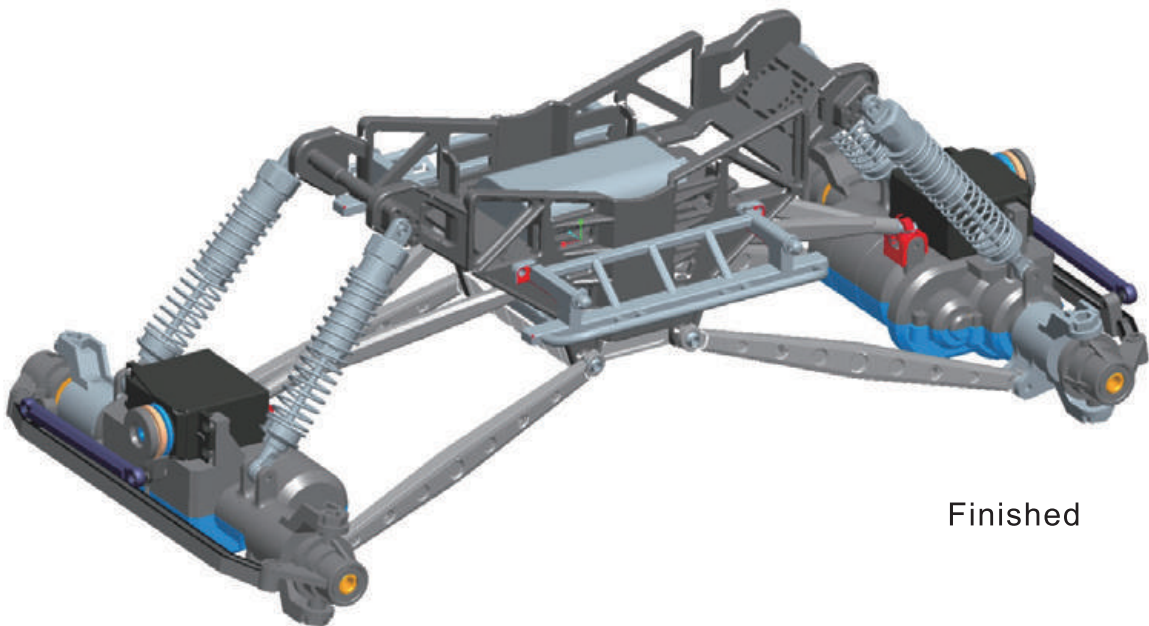
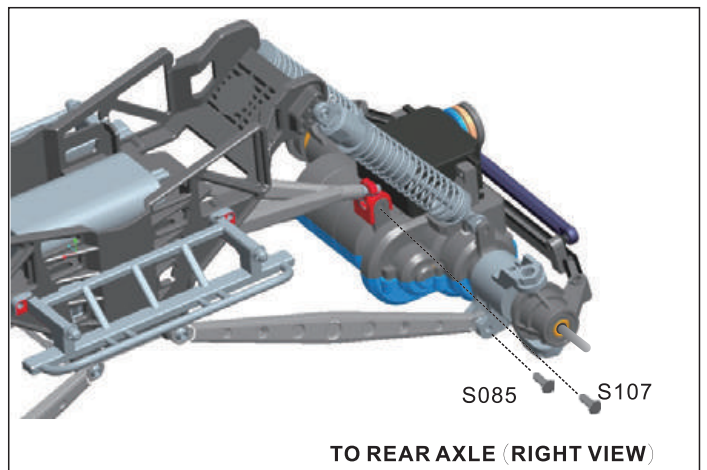
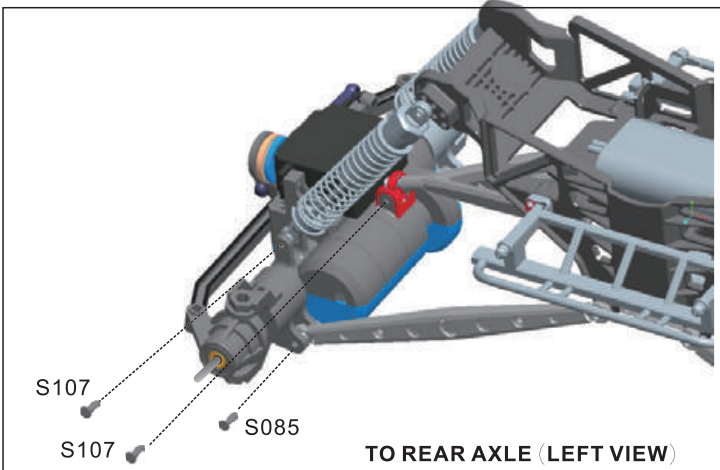
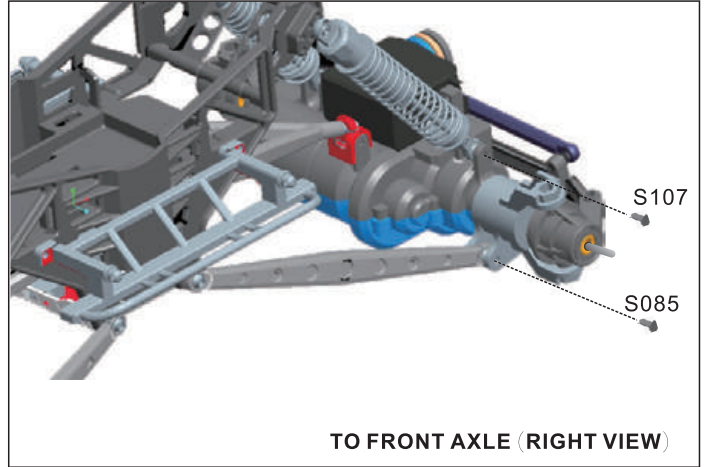
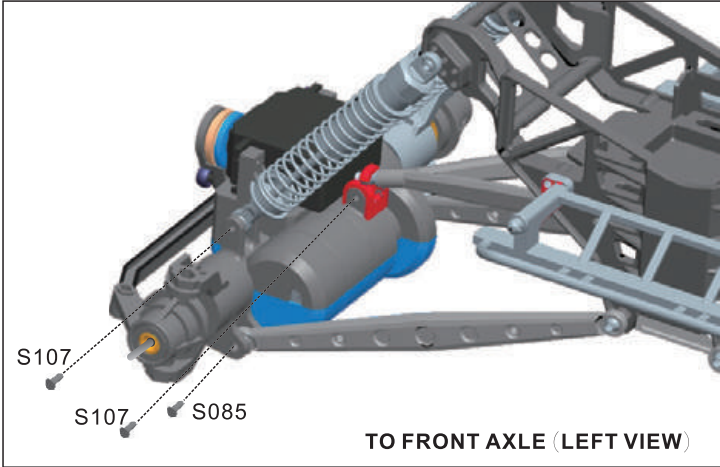

# EXPLODED VIEW - 5

RIDGEROCK

## INSTALLING WHEELS COMPLETE TO FRONT/REAR AXLE

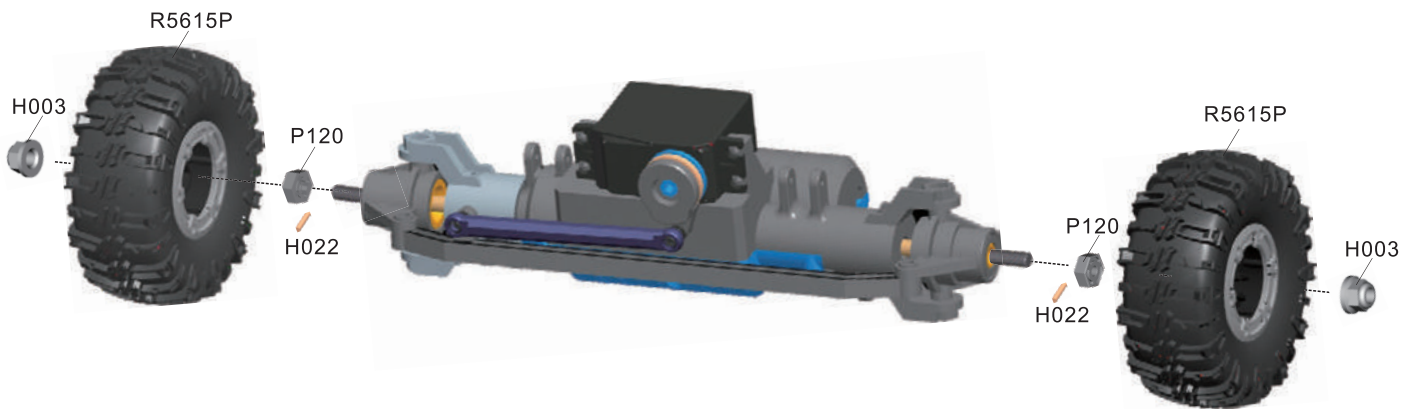

# PARTS IDENTIFICATION - 1

















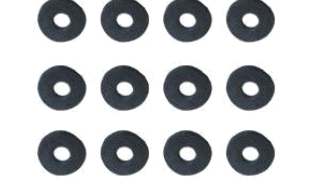

**RIDGEROCK**

<p><b>R5601</b></p>  <p>Chassis</p>	<p><b>R5602</b></p>  <p>Roll Cage</p>	<p><b>R5603</b></p>  <p>Lower Chassis Plate and Slider Rails</p>	<p><b>R5604</b></p>  <p>Suspension Links</p>
<p><b>R5605P</b></p>  <p>Wheel Bead Lock Rings (PLATED)</p>	<p><b>R5606V2</b></p>  <p>Axle Housings w/Motor Guard</p>	<p><b>R5607</b></p>  <p>Steering Links + Rings</p>	<p><b>R5608</b></p>  <p>Steering Hub Carriers</p>
<p><b>R5609V2</b></p>  <p>Steering Hubs</p>	<p><b>R5610</b></p>  <p>Wheel Shaft Outdrive Cups</p>	<p><b>R5611</b></p>  <p>Servo Saver Assembly</p>	<p><b>R5612</b></p>  <p>Gears Assembly</p>
<p><b>R5613</b></p>  <p>Tires W/ Foam Inserts</p>	<p><b>R5614</b></p>  <p>Wheels x2</p>	<p><b>R5615P</b></p>  <p>Wheels/Tires Complete (Plated Wheel Bead-lock)</p>	<p><b>R5616</b></p>  <p>Driver Helmets</p>
<p><b>R5617</b></p>  <p>Aluminum Capped Oil Filled Shocks</p>	<p><b>R5618</b></p>  <p>Threaded Wheel Axles</p>	<p><b>R5619</b></p>  <p>Axle Shaft Pins</p>	<p><b>R5620</b></p>  <p>Gear Shaft</p>

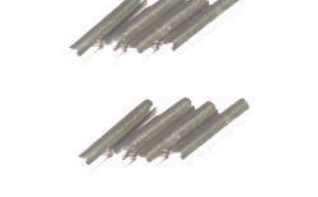



















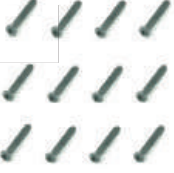

# PARTS IDENTIFICATION - 2

**RIDGEROCK**

<p><b>R5621</b></p>  <p>Front Axle Shaft</p>	<p><b>R5622</b></p>  <p>Rear Axle Shaft</p>	<p><b>R5623</b></p>  <p>Servo Saver Spring Ring</p>	<p><b>R5624</b></p>  <p>Pinion Gears (8T)</p>
<p><b>R5629TA</b></p>  <p>ESC/Receiver (W/Tamiya Plug)</p>	<p><b>R5628</b></p>  <p>RC-380 Motor</p>	<p><b>HX-6CP</b></p>  <p>3-Wire Servo (6KGS)</p>	<p><b>R5631</b></p>  <p>Ball Stud 4.8*7.8</p>
<p><b>R5630</b></p>  <p>Ball Stud 4.8*6.8</p>	<p><b>R5635</b></p>  <p>Spur Gear Spacer</p>	<p><b>H020</b></p>  <p>Body Clip A/B- Large</p>	<p><b>P100</b></p>  <p>Body Post Pads</p>
<p><b>H016</b></p>  <p>Ball Stud 5.8</p>	<p><b>P120</b></p>  <p>Wheel Hex (12mm)</p>	<p><b>H022</b></p>  <p>Wheel Hex Pin (2*10mm)</p>	<p><b>H153</b></p>  <p>E-Clip (2mm)</p>
<p><b>H013</b></p>  <p>Ball Stud 4.8*11.2</p>	<p><b>H003</b></p>  <p>Flange Lock Nut M4</p>	<p><b>P010</b></p>  <p>Cable Ties (Large)</p>	<p><b>P011</b></p>  <p>Cable Ties (Small)</p>

# PARTS IDENTIFICATION - 3

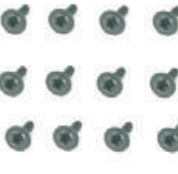
**RIDGEROCK**

<p><b>S215</b></p>  <p>Step Screw 3*6.5-3.5*5</p>	<p><b>S216</b></p>  <p>Step Screw 4*6.5-5*6.3</p>	<p><b>H032</b></p>  <p>Ball Bearing 4*7*2</p>	<p><b>H007</b></p>  <p>Ball Bearing 5*11*4</p>
<p><b>59300</b></p>  <p>Ball Bearing 5*9*3</p>	<p><b>23627</b></p>  <p>8x12x3.5mm Ball Bearings (6pcs)</p>	<p><b>S002</b></p>  <p>Round Head Self Tapping Screw 3*12mm</p>	<p><b>S004</b></p>  <p>Round Head Self Tapping Screw 3*18mm</p>
<p><b>S018</b></p>  <p>Round Head Self Tapping Screw 2.6*8mm</p>	<p><b>S030</b></p>  <p>Round Head Self Tapping Screw 3*10mm</p>	<p><b>S031</b></p>  <p>Cap Head Screw 2*8mm</p>	<p><b>S051</b></p>  <p>Round Head Self Tapping Screw 2.3*6mm</p>
<p><b>S085</b></p>  <p>Round Head Self Tapping Screw 3*15mm</p>	<p><b>S089</b></p>  <p>Round Head Self Tapping Screw 2.6*6mm</p>	<p><b>S093</b></p>  <p>Round Head Self Tapping Screw 2*6mm</p>	<p><b>S101</b></p>  <p>Round Head Screw 2.5*6mm</p>
<p><b>S102</b></p>  <p>Countersunk Head Self Tapping Screw 2*6mm</p>	<p><b>S107</b></p>  <p>Round Head Self Tapping Screw 2.6*15mm</p>	<p><b>S139</b></p>  <p>Flange Self Tapping Screw 2.6*10mm</p>	<p><b>S160</b></p>  <p>Flange Self Tapping Screw 2.6*8mm</p>

# PARTS IDENTIFICATION - 4

**RIDGEROCK**

S097	S103	12225TA	18859E-E001
 <p>Round Head Self Tapping Screw 3*22mm</p>	 <p>Set Screw 2.5*2.5mm</p>	 <p>Li-ion Battery Pack (7.4V, 1500mAH W/Small Tamiya Plug)</p>	 <p>USB Charger</p>
R5632DECH			
 <p>Body (Blue)</p>			

## ADDITIONAL ACCESSORIES:

**INCLUDED:** There are two additional servo horns and a small wrench included in this box. The additional servo arms are optional parts, which differ in shape from the servo arms installed on the vehicle from the factory. There is also a small "T" wrench to help tighten the wheel nuts or to remove/install the wheels.





- To ensure you are using the most recent version of this manual visit: [www.redcatracing.com/pages/manuals](http://www.redcatracing.com/pages/manuals)
- This manual is subject to change without prior notification.
- This product is NOT a toy, and not intended for users under 14 years of age, unless closely supervised by an adult.
- The specifications and images in the manual may vary from the actual product.
- Use caution when operating this vehicle, keeping a safe distance from yourself and others.